

Schlüsseltaster SCT

Key-operated switch SCT

DE Montageanleitung
GB Installation instructions

120527-04



Germany
GEZE GmbH
Niederlassung Süd-West
Tel. +49 (0) 7152 203 594
E-Mail: leonberg.de@geze.com
GEZE GmbH
Niederlassung Süd-Ost
Tel. +49 (0) 7152 203 6440
E-Mail: muenchen.de@geze.com
GEZE GmbH
Niederlassung Ost
Tel. +49 (0) 7152 203 6840
E-Mail: berlin.de@geze.com
GEZE GmbH
Niederlassung Mitte/Luxemburg
Tel. +49 (0) 7152 203 6888
E-Mail: frankfurt.de@geze.com
GEZE GmbH
Niederlassung West
Tel. +49 (0) 7152 203 6770
E-Mail: duesseldorf.de@geze.com
GEZE GmbH
Niederlassung Nord
Tel. +49 (0) 7152 203 6600
E-Mail: hamburg.de@geze.com
GEZE Service GmbH
Tel. +49 (0) 1802 923392
E-Mail: service-info.de@geze.com

Austria
GEZE Austria
E-Mail: austria.at@geze.com
www.geze.at
Baltic States
Lithuania / Latvia / Estonia
E-Mail: baltic-states@geze.com
Benelux
GEZE Benelux B.V.
E-Mail: benelux.nl@geze.com
www.geze.be
www.geze.nl
Bulgaria
GEZE Bulgaria - Trade
E-Mail: office-bulgaria@geze.com
www.geze.bg

China
GEZE Industries (Tianjin) Co., Ltd.
E-Mail: chinasales@geze.com.cn
www.geze.com.cn
GEZE Industries (Tianjin) Co., Ltd.
Branch Office Shanghai
E-Mail: chinasales@geze.com.cn
www.geze.com.cn

GEZE Industries (Tianjin) Co., Ltd.
Branch Office Guangzhou
E-Mail: chinasales@geze.com.cn
www.geze.com.cn

GEZE Industries (Tianjin) Co., Ltd.
Branch Office Beijing
E-Mail: chinasales@geze.com.cn
www.geze.com.cn

France
GEZE France S.A.R.L.
E-Mail: france.fr@geze.com
www.geze.fr

Hungary
GEZE Hungary Kft.
E-Mail: office-hungary@geze.com
www.geze.hu

Iberia
GEZE Iberia S.R.L.
E-Mail: info.es@geze.com
www.geze.es

India
GEZE India Private Ltd.
E-Mail: office-india@geze.com
www.geze.in

Italy
GEZE Italia S.r.l.
E-Mail: italia.it@geze.com
www.geze.it

GEZE Engineering Roma S.r.l.
E-Mail: italia.it@geze.com
www.geze.it

Korea
GEZE Korea Ltd.
E-Mail: info.kr@geze.com
www.geze.com

Poland
GEZE Polska Spz o.o.
E-Mail: geze.pl@geze.com
www.geze.pl

Romania
GEZE Romania S.R.L.
E-Mail: office-romania@geze.com
www.geze.ro

Russia
OOO GEZE RUS
E-Mail: office-russia@geze.com
www.geze.ru

Scandinavia Sweden
GEZE Scandinavia AB
E-Mail: sverige.se@geze.com
www.geze.se

Scandinavia Norway
GEZE Scandinavia AB avd. Norge
E-Mail: norge.se@geze.com
www.geze.no

Scandinavia Denmark
GEZE Danmark
E-Mail: danmark.se@geze.com
www.geze.dk

Singapore
GEZE (Asia Pacific) Pte, Ltd.
E-Mail: gezesea@geze.com.sg
www.geze.com

South Africa
GEZE South Africa (Pty) Ltd.
E-Mail: info@gezesa.co.za
www.geze.co.za

Switzerland
GEZE Schweiz AG
E-Mail: schweiz.ch@geze.com
www.geze.ch

Turkey
GEZE Kapi ve Pencere Sistemleri
E-Mail: office-turkey@geze.com
www.geze.com

Ukraine
LLC GEZE Ukraine
E-Mail: office-ukraine@geze.com
www.geze.ua

United Arab Emirates/GCC
GEZE Middle East
E-Mail: gezeme@geze.com
www.geze.ae

United Kingdom
GEZE UK Ltd.
E-Mail: info.uk@geze.com
www.geze.com



GEZE GmbH
Reinhold-Vöster-Straße 21–29 Tel.: 0049 7152 203 0
71229 Leonberg Fax: 0049 7152 203 310
Germany www.geze.com

Bezeichnung / Description

Der Schlüsseltaster ermöglicht berechtigten Personen die Nutzung eines GEZE Bedienterminals oder das Erzeugen eines Ansteuersignals.

- Schlüsseltaster, 1 pol. mit 1-fach Rahmen AS 500 alpinweiß, ohne Profilhalbzylinder, Mat. Nr. 117996

Key-operated switch enables authorized persons to use a GEZE operating terminal or to generate a activation signal.

- Key-operated switch, single-pole with 1 frame AS 500 alpine white, without profile half cylinder, Mat. No. 117996

Sicherheitshinweis / Safety instructions

Bitte die Sicherheitshinweise des Türantriebs beachten / please follow the safety instructions of the door drive.

Zubehör / Accessories

Name	Mat. Nr.
AS 500 UP-Rahmen / AS 500 concealed frame	
▫ 1-fach / single	115376
▫ 2-fach / double	115377
▫ 3-fach / triple	115378
▫ 4-fach / quadruple	115379
▫ 5-fach / quintuple	115380
AS 500 Aufputzdose / AS 500 surface-mounted box	
▫ 1-fach / single	120503
▫ 2-fach / double	128609
▫ 3-fach / triple	133206
Zwischenrahmen 55x55 für ST 550 alpinweiß / intermediate frame 55x55 for ST 550 alpine white	155851
Zwischenrahmen 55x55 für LS 990 alpinweiß / intermediate frame 55x55 for LS 990 alpine white	148997
Zwischenrahmen 55x55 für LS 990 edelstahl / intermediate frame 55x55 for LS 990 stainless steel	131822

Name	Mat. Nr.
AS 500 Blindabdeckung / AS 500 dummy cover	115402
Profilhalbzylinder / profile half cylinder	090176
Schaltkontakt / switch contact	024467

Passende Schalterprogramme / Matching switch ranges

- | | |
|---|---------------|
| Jung | Gira |
| ▫ AS 500 | ▫ Standard 55 |
| ▫ LS 990 (mit Zwischenrahmen / with intermediate frame) | ▫ E2 |
| ▫ ST550 (mit Zwischenrahmen / with intermediate frame) | ▫ Event |
| | Feller |
| | ▫ EDIZIOdue |

Merten
▫ System M

Berker
▫ B3
▫ B7
▫ S1

Technische Daten / Technical data

- | | |
|---------------------------------------|---------------|
| ▫ Schaltspannung / Switching voltage: | max. 240 V AC |
| ▫ Schaltstrom / Switching current: | max. 4 A |
| ▫ Schutzart / Protection rating: | IP 40 |

Normen / Standards

- DIN 18 252 - Profilzylinder für Türschlösser / profile cylinder for door locks

Maßzeichnungen / Dimensional drawings

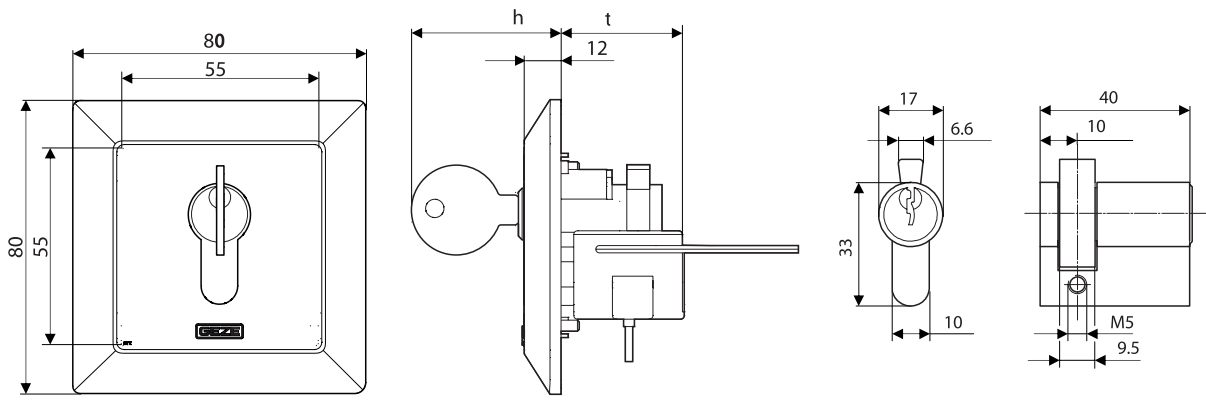

Zusammenbau / Assembly

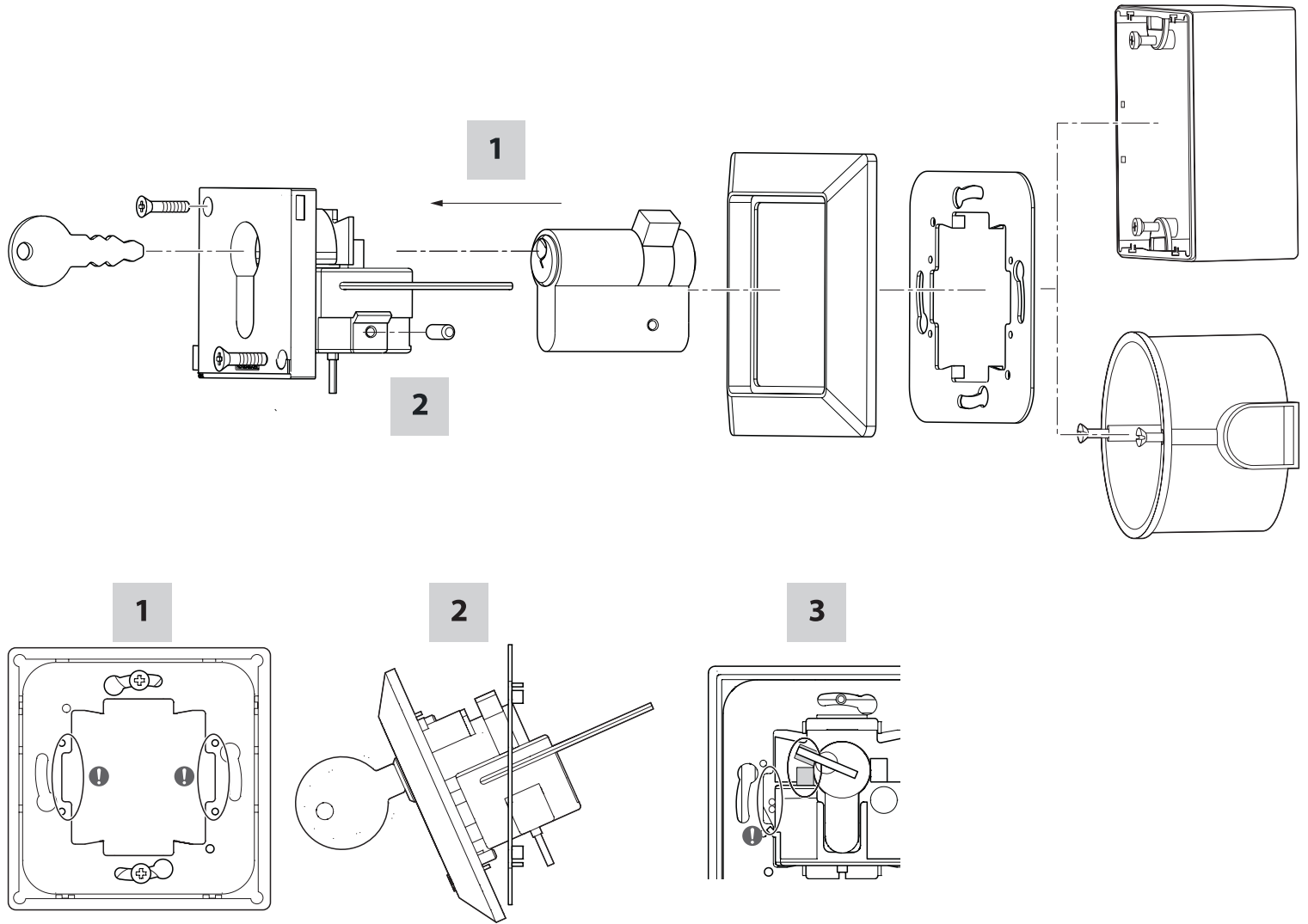

Schablone für Pfostenmontage ohne Rahmen / Template for installation on a post without Frame



Die Papierschablone kann sich abhängig von der Luftfeuchtigkeit maßlich verändern. Verbindlich sind daher nur die Maßangaben.

▶ Vor der Verwendung Papierschablone maßlich kontrollieren und ggf. korrigieren.

The dimensions of the paper template can change depending on air humidity. For this reason, only our dimensional specifications are applicable.

▶ Before using the paper template check the dimensions and correct if necessary.

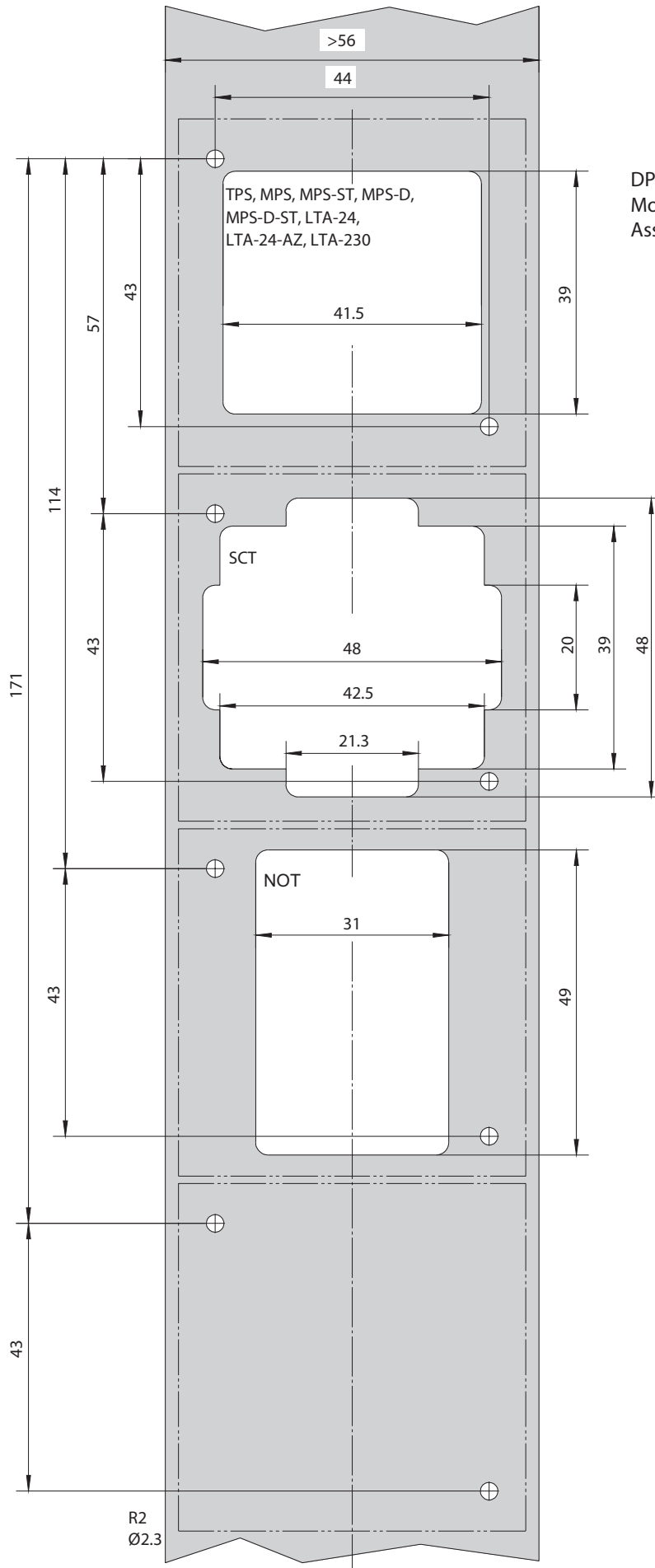

DPS, LTA-LSA:
Montage in Pfosten nicht möglich. /
Assembly on a post not possible.

Schaltpläne / Circuit diagrams

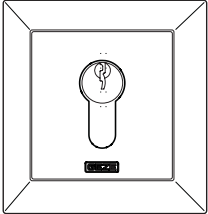
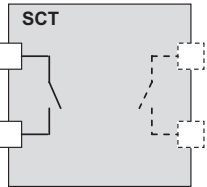
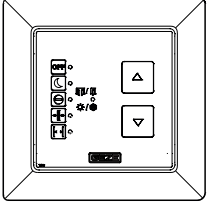
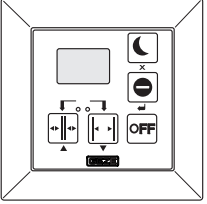
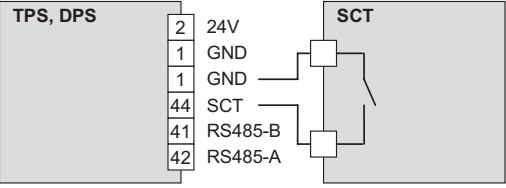
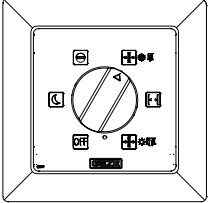
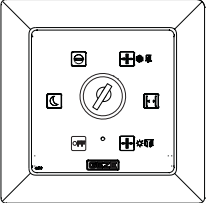
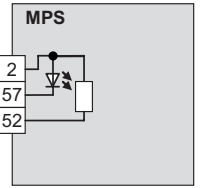
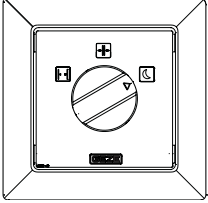
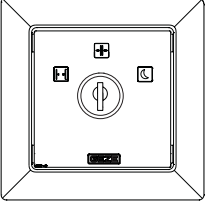
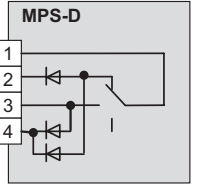
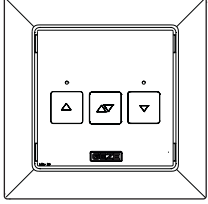
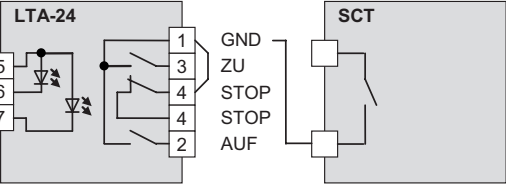
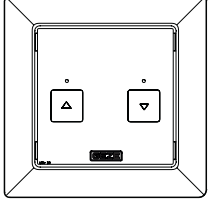
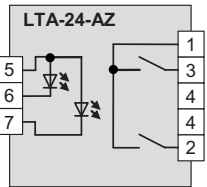
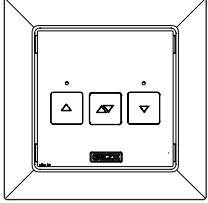
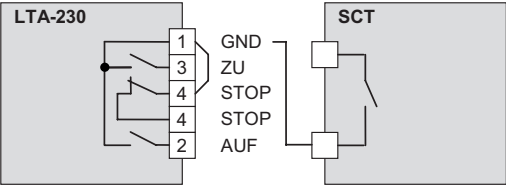
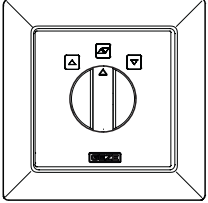
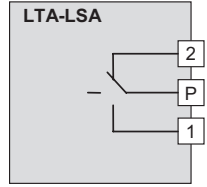
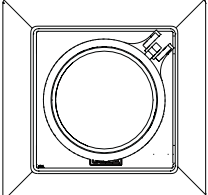
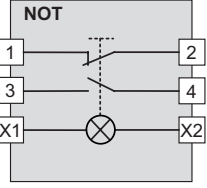
Taster / Switches	Bezeichnung / Description	Mat. Nr. / Mat.No.	Taster / Switches	Bezeichnung / Description	Mat. Nr. / Mat. No.	Schaltplan / Circuit diagram	h [mm]	t [mm]
	SCT (1-pol.)	117996		-	-		11	31.9
	TPS TPS-SCT TPS-KDT TPS-KDT-SCT DPS mit/with OFF DPS ohne/ without OFF DPS mit/with OFF SCT	113231 113232 126582 126583 151524 155809 155810		TPS, DPS			11.3	5.3 31.9
	MPS	113226		MPS-ST	113227		24	36
	MPS-D	118417		MPS-D-ST	118418		24	36
	LTA-24 LTA-24-SCT	118473 127176		LTA-24			11	26
	LTA-24-AZ	129393		LTA-24-AZ			11	26
	LTA-230 LTA-230-SCT	118474 118475		LTA-230			11	26
	LTA-LSA	118476		LTA-LSA			24	32
	NOT	123132		NOT			54	56